

WaitForMe

INVOCA[®] 



WaitForMe

INVOCA[®] 



**Waiting. on.
Hold. Sucks!**



Customers

Nobody likes to wait on hold



83.8%

Users hang up and don't call back



Businesses

Keep clients happy

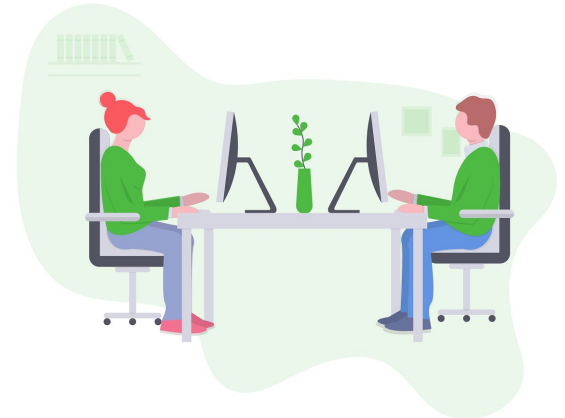
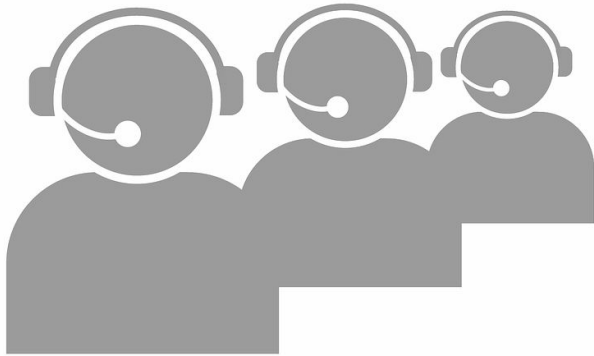

59%

Will not return after bad experience

60%

Hang up while on hold

\$75 billion

Lost due to bad customer service



59%

Will not return after bad experience

60%

Hang up while on hold

\$75 billion

Lost due to bad customer service



59%

Will not return after bad experience

60%

Hang up while on hold

\$75 billion

Lost due to bad customer service



53%

Of business have IVRs

60%

People will bypass IVR and end up on hold



53%

Of business have IVRs

60%

People will bypass IVR and end up on hold



Wait For Me

An app that waits on
hold for you



Our Solution

Call business using WaitForMe

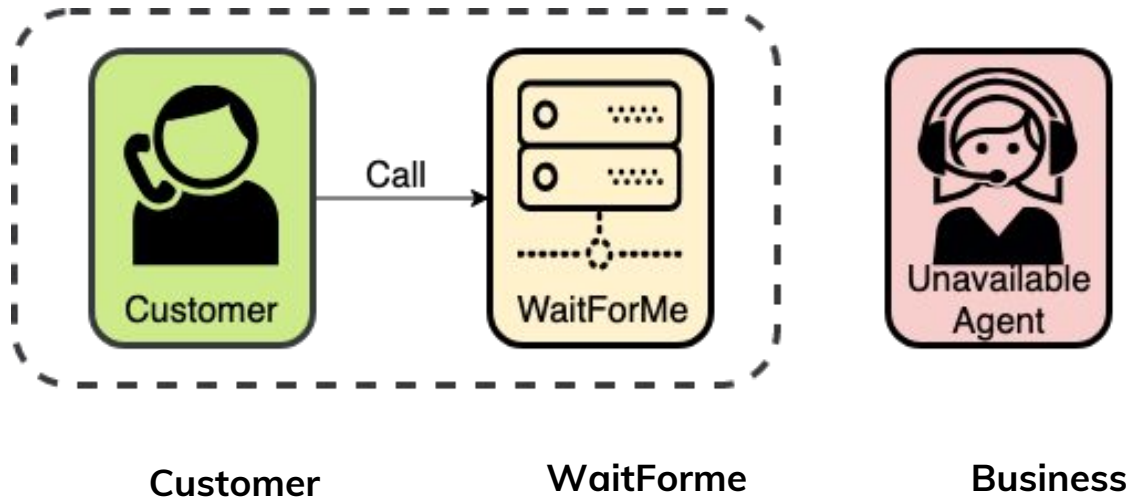

Our Solution

WaitForMe waits on hold

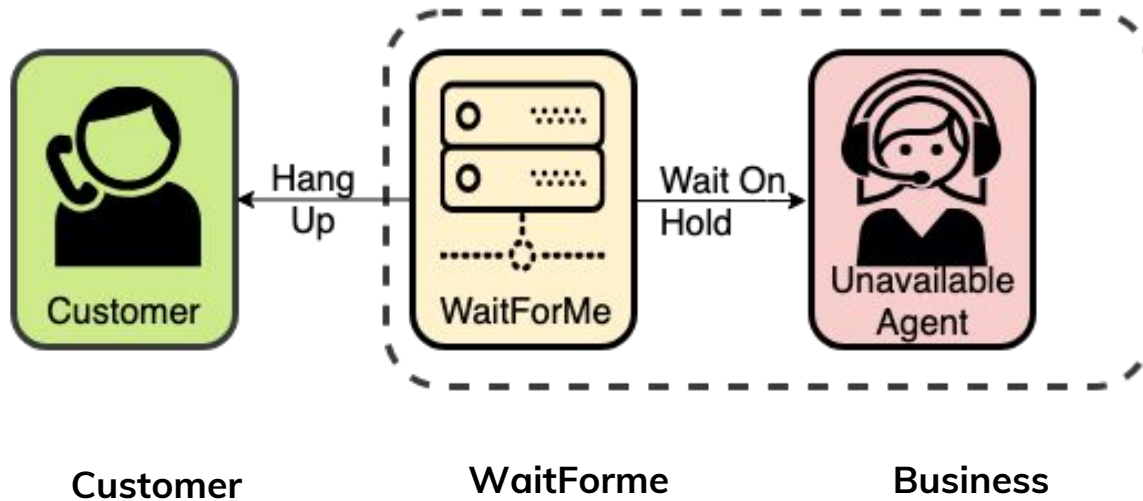

Our Solution

WaitForMe calls you back

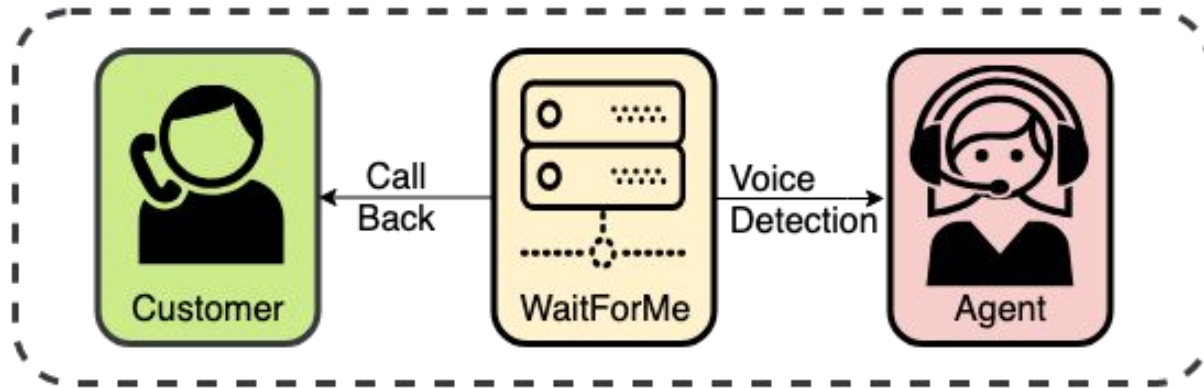

Customer

WaitForme

Business

Let's make a call now !



No more Waiting!





 **Google App Engine**

 Wait For Me
Server

 Redis
Database

Architecture

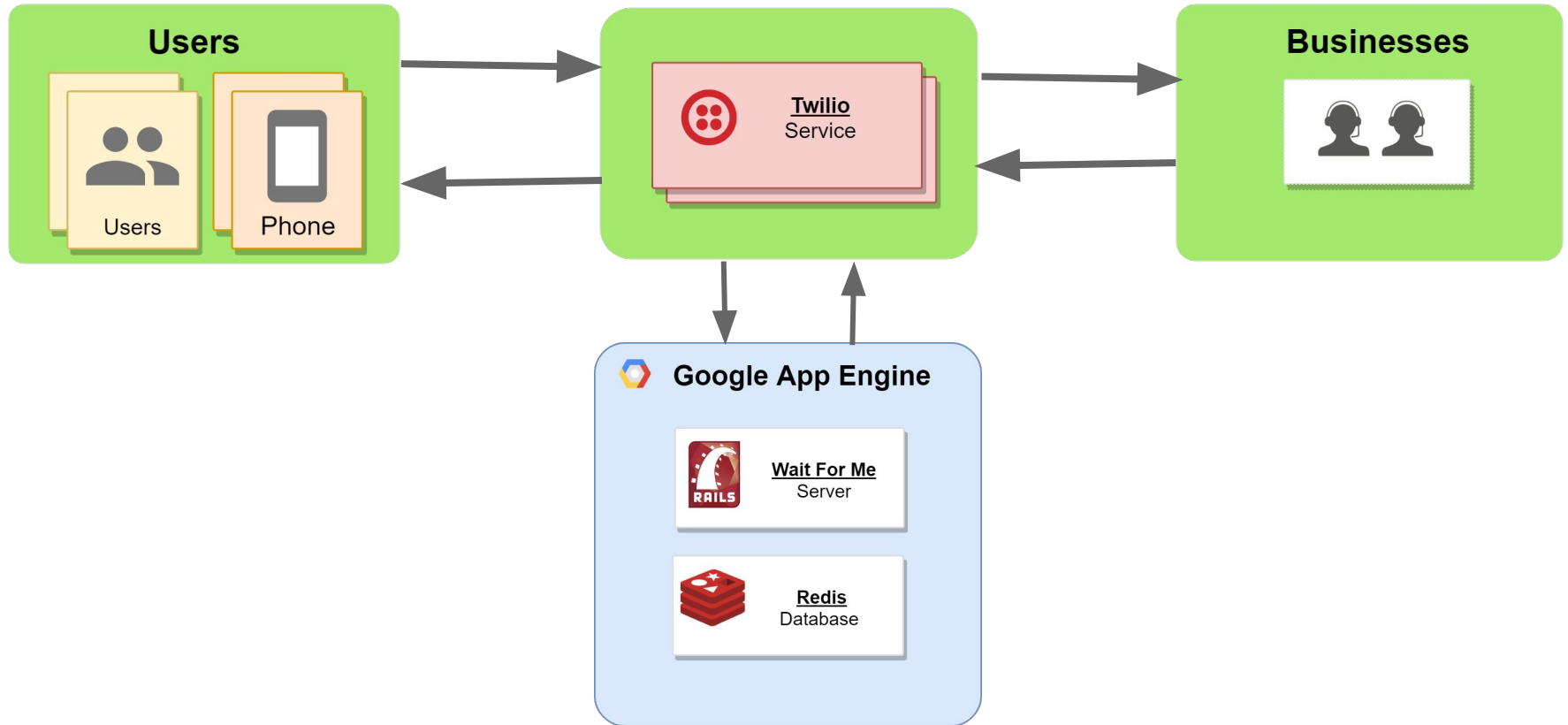

Let's get back to the customer!

Call the customer back when the business is free

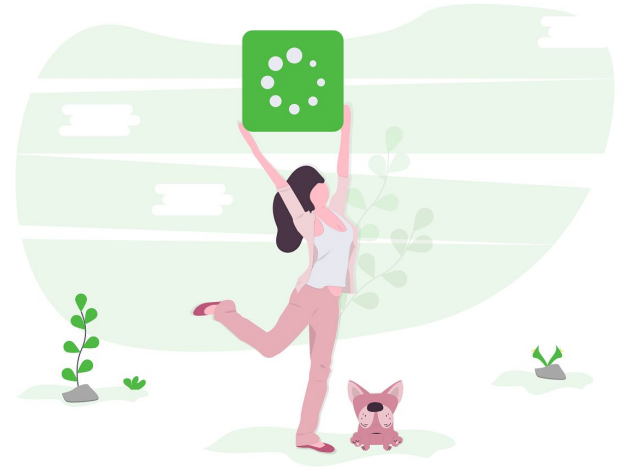

Wait For Me

- **Simple and easy to use**
- Waits on hold for you
- Helps business

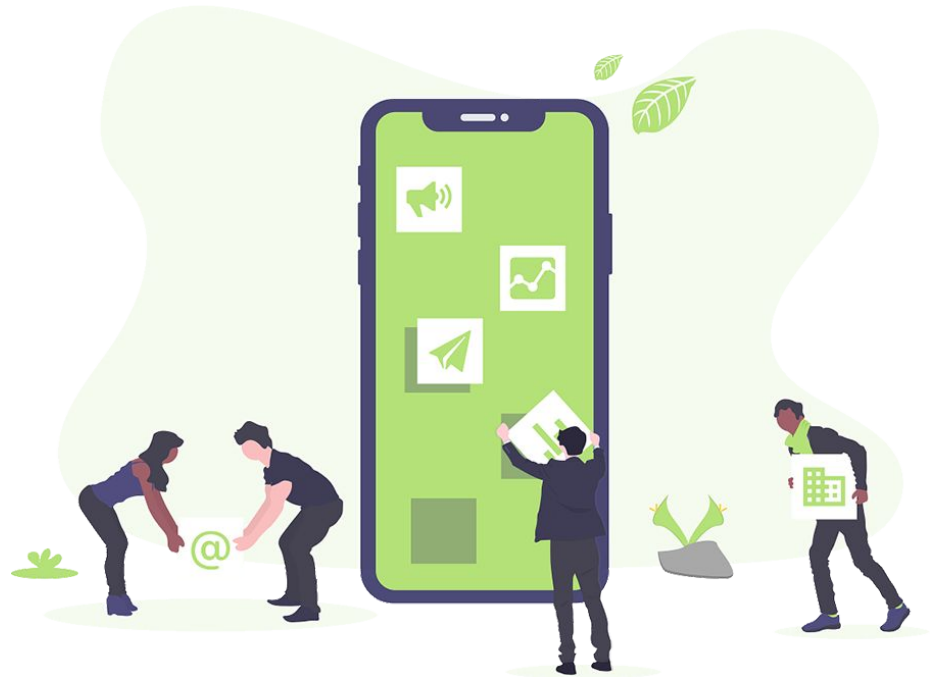

Wait For Me

- Simple and easy to use
- **Waits on hold for you**
- Helps business



Wait For Me

- Simple and easy to use
- Waits on hold for you
- **Helps business**

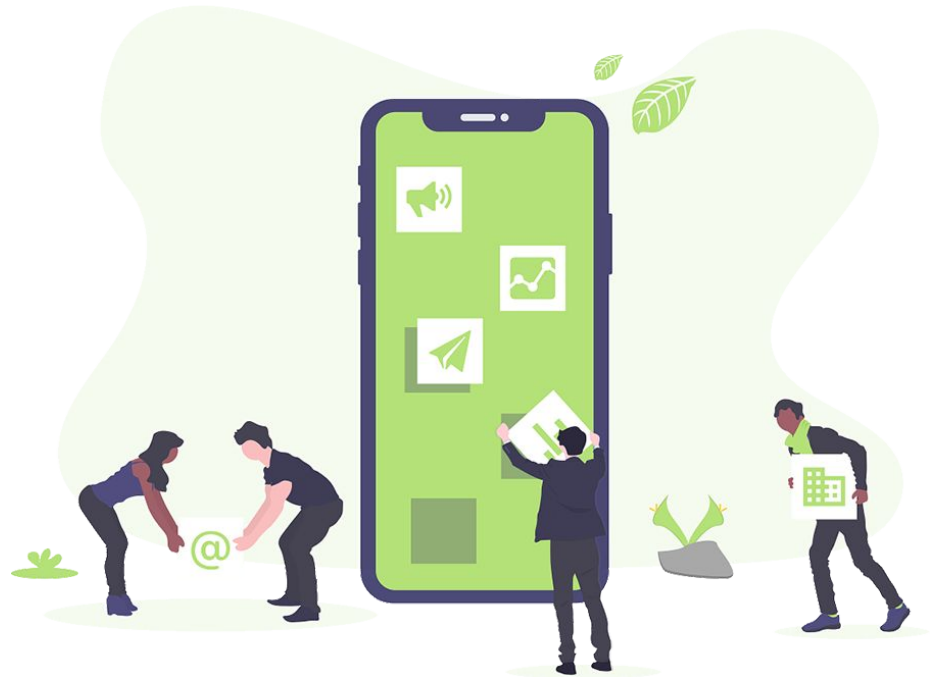

What's next?

- **Offer a Software as a service(SAAS) model**
 - Improve customer service
 - Analytics
 - Simply call, message, or click a link
 - Eliminate waiting



What's next?

- Offer a Software as a service(SAAS) model
 - **Improve customer service**
 - Analytics
 - Simply call, message, or click a link
 - Eliminate waiting



What's next?

- Offer a Software as a service(SAAS) model
 - Improve customer service
 - **Analytics**
 - Simply call, message, or click a link
 - Eliminate waiting



What's next?

- Offer a Software as a service(SAAS) model
 - Improve customer service
 - Analytics
 - **Simply call, message, or click a link**
 - Eliminate waiting



What's next?

- Offer a Software as a service(SAAS) model
 - Improve customer service
 - Analytics
 - Simply call, message, or click a link
 - **Eliminate waiting**



One Last Thing...

Alexa

- **Hands-free**
- Don't need to know number
- Just need business name
- Same process
- Makes app easier to use



Alexa

- Hands-free
- **Don't need to know number**
- Just need business name
- Same process
- Makes app easier to use



Alexa

- Hands-free
- Don't need to know number
- **Just need business name**
- Same process
- Makes app easier to use



Alexa

- Hands-free
- Don't need to know number
- Just need business name
- **Same process**
- Makes app easier to use



Alexa

- Hands-free
- Don't need to know number
- Just need business name
- Same process
- **Makes app easier to use**



Wait For Me

An app that waits on
hold for you

Thanks for listening!

